



# USER MANUAL

PowerMust 6054 LCD (6KVA),RM, Online, IEC

PowerMust 10900 LCD (10KVA),RM, Online, IEC

# Contents

<b>1. Introduction</b> .....	<b>1</b>
<b>2. Safety Warnings</b> .....	<b>4</b>
2.1 Installation .....	4
2.2 Operation.....	5
2.3 Maintenance, servicing and faults .....	6
2.4 Transport .....	7
2.5 Storage.....	7
2.6 Standards .....	7
<b>3. Installation</b> .....	<b>9</b>
3.1 Inspecting the Equipment.....	9
3.2 Unpacking the Cabinet.....	9
3.3 UPS Rear Panel .....	12
3.4 UPS Front Panel.....	13
3.5 Rackmount Setup .....	14
3.6 Tower Setup.....	18
3.7 Installation of UPS with AC inputs .....	19
<b>4. Power cables connection &amp; Startup</b> .....	<b>21</b>
4.1 Access to terminal block.....	22
4.2 Common input sources connection .....	23
4.3 Separate input sources connection .....	24
4.4 Frequency converter connection .....	25
4.5 UPS Initial Startup.....	25
4.6 Parallel operation.....	26
<b>5. Operation</b> .....	<b>26</b>
5.1 Display Panel.....	32
5.2 Operating mode.....	34
5.3 Turning on and Turning off UPS .....	37
5.4 LCD operation .....	39
<b>6. UPS Maintenance</b> .....	<b>48</b>
6.1 UPS and Battery Care .....	48
6.2 Transporting the UPS.....	48
6.3 Storing the UPS and Batteries.....	49
6.4 Testing Batteries .....	49
6.5 Recycling the Used Battery or UPS.....	50
<b>7. Specifications</b> .....	<b>51</b>
<b>8. Troubleshooting</b> .....	<b>53</b>

8.1 Typical Alarms and Conditions .....	53
<b>9. Communication.....</b>	<b>58</b>
9.1 RS-232 and USB Communication Ports .....	58
9.2 Network Management Card (Optional) .....	60
9.3 UPS Management Software.....	60
9.4 REPO Function.....	61

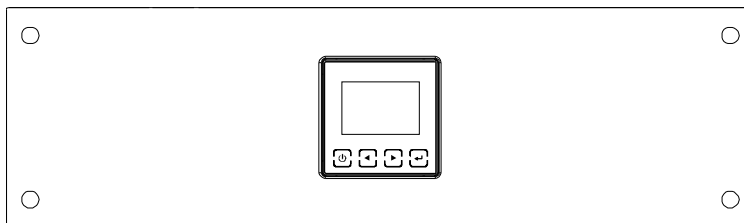
# 1. Introduction

This Online R/T Series is an uninterruptible power supply incorporating double-conversion technology. It provides perfect protection specifically for computer equipment, communication systems to computerized instruments. It protects your sensitive electronic equipment from basic power problems such as power failures, power sags, power surges, brownout, and line noise.

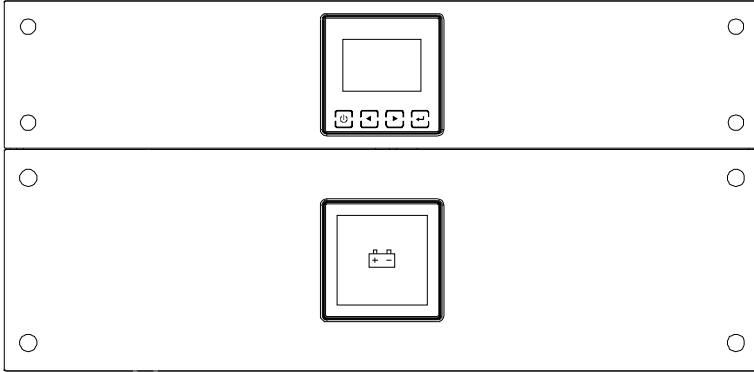
Power outages can occur when you least expect them and power quality can be erratic. These power problems have the potential to corrupt critical data, destroy unsaved work sessions, and damage hardware — causing hours of lost productivity and expensive repairs.

With the Online R/T UPS, you can safely eliminate the effects of power disturbances and guard the integrity of your equipment. The UPS can handle array--network devices flexibility that makes it the best choice for protect your LANs, servers, workstations, and other electrical equipment.

Online R/T UPS as Rack installation:

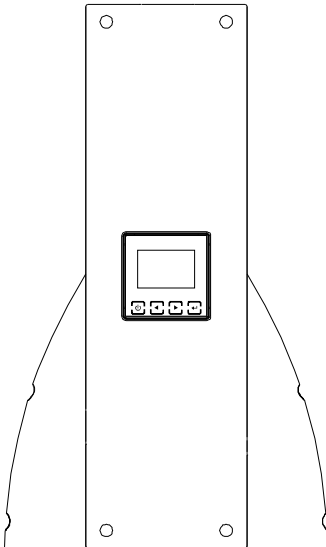


**Figure 1-1: Online R/T 6K UPS**

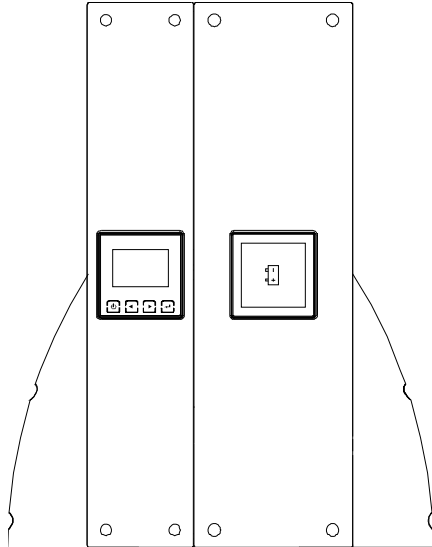


**Figure 1-2: Online R/T 10K UPS**

Online R/T UPS as Tower installation.



**Figure 1-3: Online R/T 6K UPS**



**Figure 1-4: Online R/T 10K UPS**

Providing outstanding performance and reliability, the UPS's unique benefits include:

- Online UPS design with pure sine wave output.
- True online double-conversion technology with high power density, utility frequency independence, and generator compatibility.
- Intelligent Battery Management technology that uses advanced battery management to increase battery service life, optimize recharge time.
- Selectable High Efficiency mode of operation.
- Start-on-battery capability for powering up the UPS even if utility power is not available.
- Standard communication options: one RS-232 communication port, one USB communication port.
- Optional connectivity cards with enhanced communication capabilities.
- Extended runtime with up to four Extended Battery Modules (EBMs) per UPS.
- Optional installation method — Rack & Tower.
- Remote shutdown control through the Remote Emergent Power-off (REPO) port.
- Maintenances are simplified by allowing the safe replacement of batteries without powering down the UPS.
- Parallel with another Online R/T UPS, max amount is 2.
- Optional Rack Slider.
- PDU is standard configuration with maintenance bypass switch.

## 2. Safety Warnings

### **CAUTION:**

Before performing the procedures in this document, read and follow the safety instructions and important regulatory information in your Safety, Environmental, and Regulatory Information document.

**IMPORTANT SAFETY INSTRUCTIONS FOR EACH STEP SAVE THESE INSTRUCTIONS.**

### 2.1 Installation

- Condensation may occur if the UPS is moved directly from a cold to a warm environment. The UPS must be absolutely dry before being installed. Please allow an acclimatization time of at least two hours.
- Do not install the UPS near water or in damp environment.
- Do not install the UPS where it would be exposed to direct sunlight or near heat.
- Do not block ventilation openings in the UPS's housing.
- Place cables in such a way that no one can step on or trip over them.
- UPS has provided earthed terminal, in the final installed system configuration, equipotent earth bonding to the external UPS battery cabinets.
- An integral single emergency switching device which prevents further supply to the load by the UPS in any operation mode should be provided in the building wiring installation.
- An appropriate disconnect device as short-circuit backup protection should be provided in the building wiring installation.
- For three-phase equipment connection to an IT power system, a four-pole device which disconnect all phase conductors and

the neutral conductor should be provided in the building wiring installation.

- This is permanently connected equipment , it must be installed by qualified maintenance personnel.
- **For permanently connected equipment:** make sure that a readily accessible disconnect device is incorporated in the building installation wiring.

To reduce the risk of fire, connect only to a circuit provided with branch circuit overcurrent protection with an ampere rating in accordance with the IEC/EN 60934 standard or your local electrical code and have a contact air gap of at least 3 mm.

Uninterruptible power supply output power	240V
PowerMust 6054 LCD RM	40 amp 2-pole circuit breaker
PowerMust 10900 LCD RM	63 amp 2-pole circuit breaker

- You can connect four extended battery modules to the uninterruptible power supply.
- Earthing connection is essential before connecting to the building wiring terminal.

## 2.2 Operation

- Do not disconnect the earth conductor cable from the UPS or the building wiring terminals in any time since this would cancel the protective earthing of the UPS system and all connected loads.
- The UPS output terminal block may be electrically active even if the UPS system is not connected to the building wiring terminal.
- In order to completely disconnect the UPS, firstly press the OFF button, and then disconnect the mains lead.



- Ensure that no liquid or other foreign objects can enter the UPS.
- The UPS can be operated by any individual without previous experience.

## **2.3 Maintenance, servicing and faults**

- The UPS operates with hazardous voltages. Maintenance should be carried out only by qualified maintenance personnel.
- Caution - risk of electric shock. Even after the unit is disconnected from the mains power supply (building wiring terminal), components inside the UPS are still connected to the battery which have potentially dangerous.
- Before carrying out any kind of service and/or maintenance, please disconnect the batteries. Verify that no current is present and no hazardous voltage exist in the capacitor or BUS capacitor terminals.
- Batteries must be replaced only by qualified personnel.
- Caution – the risk of electric shock. The battery circuit is not isolated from the input voltage. Hazardous voltage may occur between the battery terminals and the ground. Verify that no voltage is present before servicing!
- Batteries have a high short-circuit current and pose a risk of shock. Take all precautionary measures specified as below and any other measures necessary when working with batteries:
  - 1) Remove all jewellery, wristwatches, rings and other metal objects
  - 2) Use only tools with insulated grips and handles.
  - 3) When changing batteries, replace with the same quantity and the same type of batteries.
  - 4) Do not attempt to dispose of batteries by burning them. It could cause explosion.

- 5) Do not open or destroy batteries. Effluent electrolyte can cause injury to the skin and eyes. It may be toxic.
- Please replace the fuse only with the same type and of the same amperage in order to avoid fire hazards.
- Do not dismantle the UPS, except the qualified maintenance personnel.

## 2.4 Transport

- Please transport the UPS only in the original packaging (to protect against shock and impact).

## 2.5 Storage

- The UPS must be stockpiled in the room where is ventilated and dry.

## 2.6 Standards

<b>* Safety</b>	
IEC/EN 62040-1	
<b>* EMI</b>	
Conducted Emission.....:IEC/EN 62040-2	Category C2
Radiated Emission.....:IEC/EN 62040-2	Category C2
<b>*EMS</b>	
ESD.....:IEC/EN 61000-4-2	Level 4
RS.....:IEC/EN 61000-4-3	Level 3
EFT..... :IEC/EN 61000-4-4	Level 4
SURGE..... :IEC/EN 61000-4-5	Level 4
CS..... :IEC/EN 61000-4-6	Level 3

Power-frequency Magnetic field.... :IEC/EN 61000-4-8	Level 3
Low Frequency Signals.....:IEC/EN 61000-2-2	
<b>Warning:</b> This is a product for commercial and industrial application in the second environment-installation restrictions or additional measures may be needed to prevent disturbances.	

# 3. Installation

This chapter explains:

- Equipment inspection
- Unpacking the cabinet
- Checking the Accessory
- UPS setup and installation
- Connecting the internal battery
- Connecting the EBM(Extended Battery Modules)
- Installation requirements

## 3.1 Inspecting the Equipment

If any equipment has been damaged during shipment, keep the shipping cartons and packing materials for the carrier or place of purchase and file a claim for shipping damage. If you discover damage after acceptance, file a claim for concealed damage.

**Note:** Check the battery recharge date on the shipping carton label. If the date has passed and the batteries were never recharged, do not use the UPS. Contact your service representative.

## 3.2 Unpacking the carton

**CAUTION:** If the carton unpacks in a low-temperature of environment it may cause condensation of moisture in or on the cabinet of UPS. Do not install the UPS until the inside and outside of the cabinet is absolutely dry to prevent hazard of electric shock.

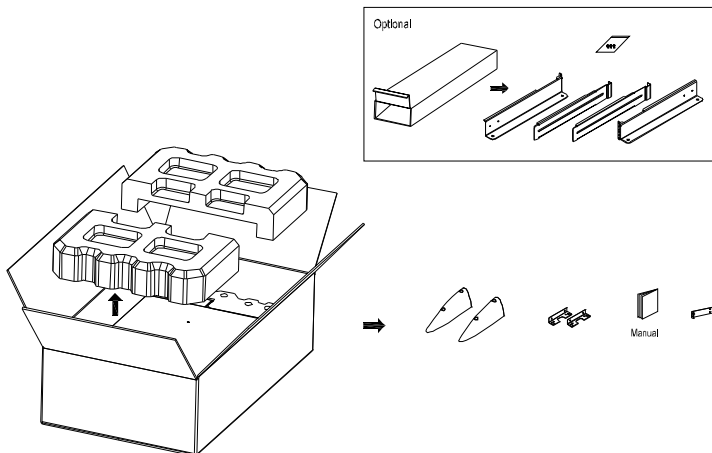
**CAUTION:** The cabinet is heavy. Refer following instruction to unpack and move the cabinet from packing carton.

Be careful when moving and opening the carton. The unpacking steps are shown as below:

**Step 1:**

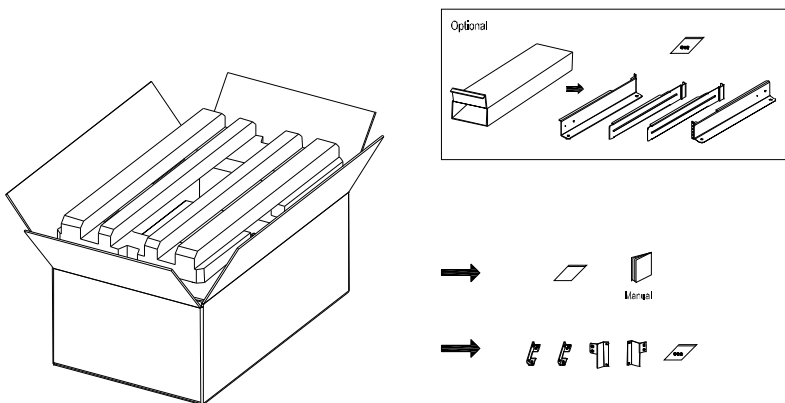
Open the outer carton and remove the accessories out of the carton (see Figure 3-1&3-2).

Online R/T 6K UPS:



**Figure 3-1: Unpacking the carton of 6K UPS**

Online R/T 10K UPS



**Figure 3-2: Unpacking the carton of 10K UPS**



**CAUTION:**

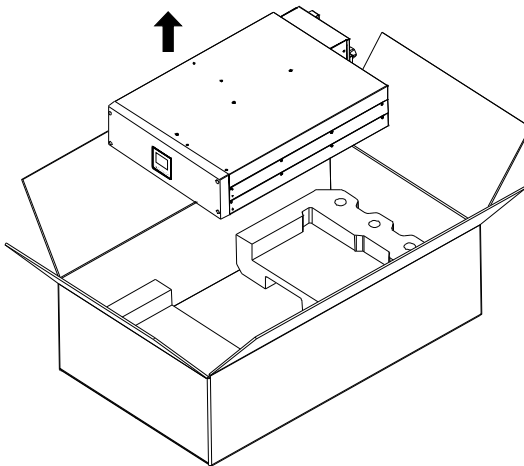
The cabinet is heavy. Lifting the cabinet out of the carton required two persons at least.

**Step 2:**

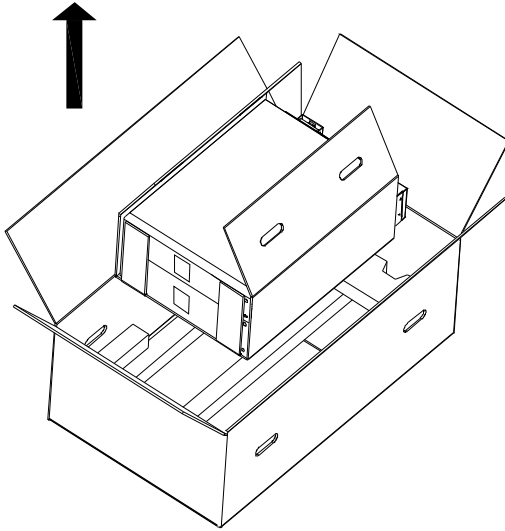
With one person on each side, carefully lift the cabinet out of the outer carton using the handles on the cardboard and set it on a flat, stable surface (see Figure 3-3&3-4).

Place the cabinet in a protected area that has adequate airflow and is free of humidity, flammable gas, and corrosion.

Lifting the Cabinet:



**Figure 3-3: Lifting the Cabinet out of 6K UPS carton**



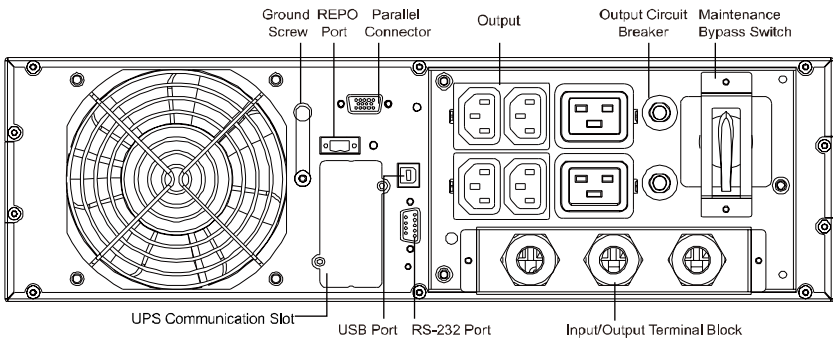
**Figure 3-4: Lifting the Cabinet out of 10K UPS carton**

**Step 3:**

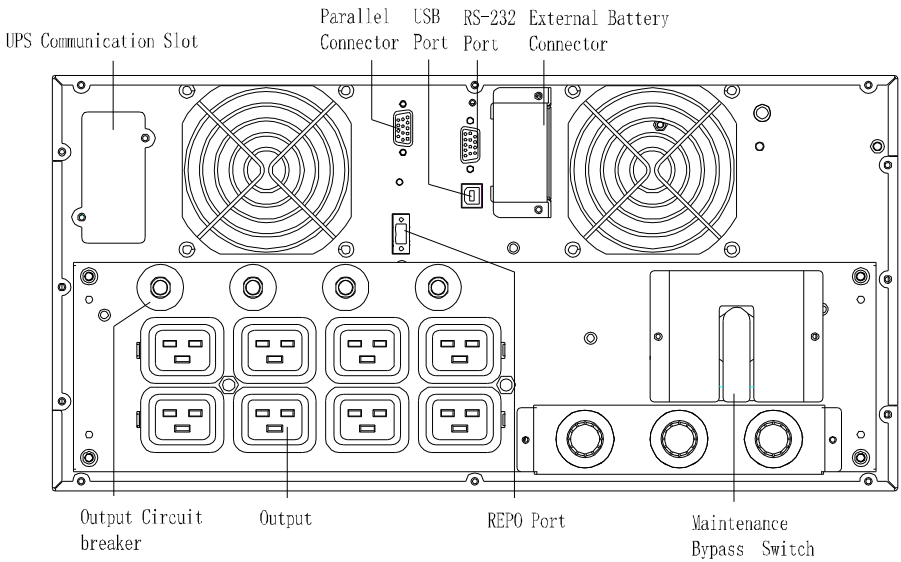
Discard or recycle the packaging in a responsible manner, or store it for future use.

**3.3 UPS Rear Panel**

This section shows the rear panel of the Online R/T models.



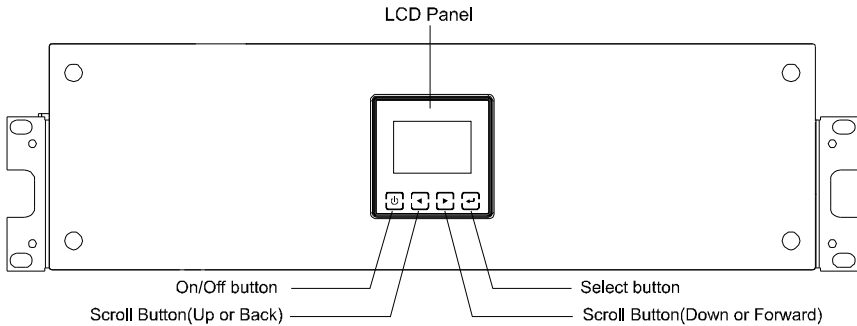
**Figure 3-5: PowerMust 6054 LCD RM**



**Figure 3-6: PowerMust 10900 LCD RM**

### 3.4 UPS Front Panel

This section shows the front panel of the Online R/T UPS. The Online series have the same LCD panel and the same control button.



**Figure 3-7: The Online R/T UPS Front Panel**



### 3.5 Rack mount Setup

**CAUTION:**

The cabinet is heavy, so:

- 1) Remove the battery tray from the UPS before lifting.
- 2) Lifting the cabinets into the rack requires a minimum of two people.

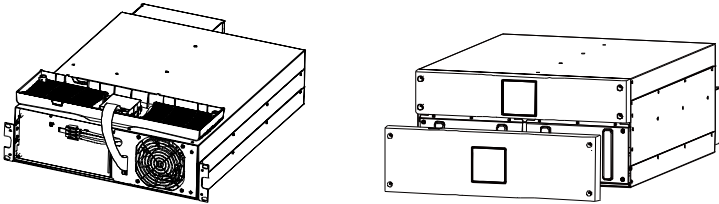
**CAUTION:** Removing the batteries required precautions, which should be performed or supervised by personnel with knowledge of batteries . Keep unauthorized personnel away from batteries.

**CAUTION:** If installing an EBM(Extended Battery Module), install the EBM directly below the UPS.

#### 3.5.1 Install the UPS and EBM (Extended Battery Modules) in a rack:

1. Open the front panel and put it above the UPS.

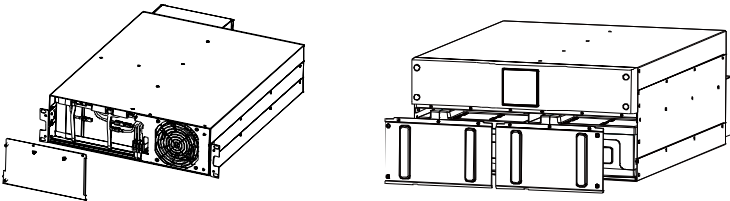
2.



**Figure 3-8. Open the front panel (left: 6K Model, right: 10K Model)**

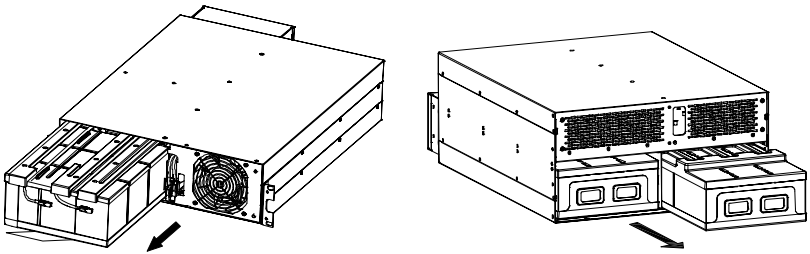
3. Remove the battery protection plate:

4.



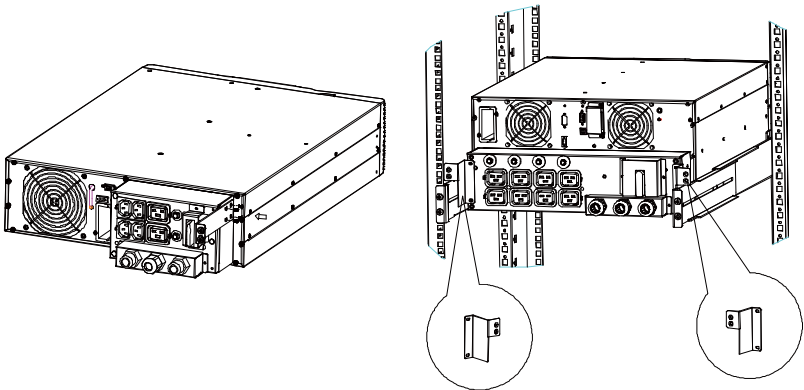
**Figure 3-9. Removing the Battery Protection Plate**

5. Pull the battery tray out using the plastic tabs and then remove the battery tray.



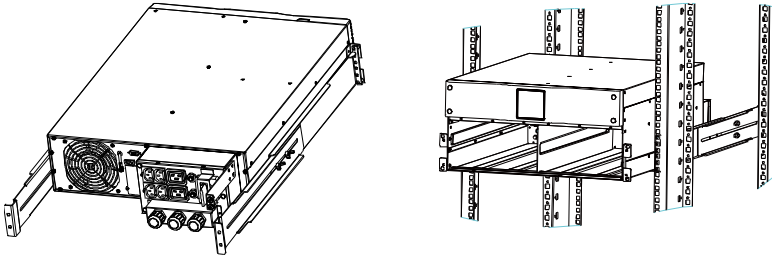
**Figure 3-11: Removing the Battery Tray**

6. Install the PDU's ears to the UPS



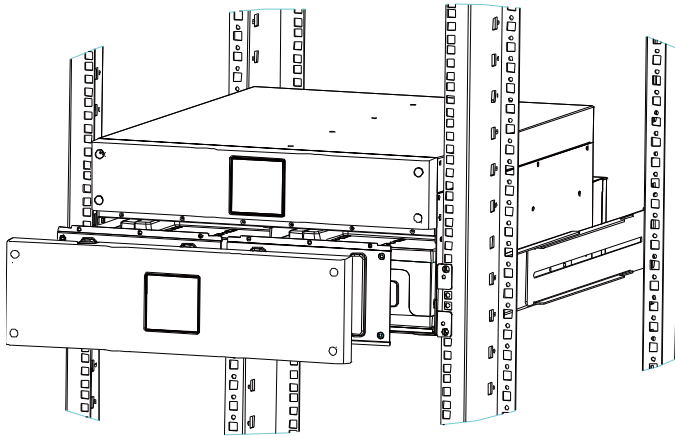
**Figure 3-12. Install the PDU's ears to the UPS**

7. Select the proper holes in the rail for positioning the cabinet in the desired location in the rack. Locate the rails at the bottom of the 3U space allocated for the each UPS and EBM.
8. Install the sliding rails in the rack, then install the UPS in the sliding rail.



**Figure 3-13. Install the sliding rails**

9. For 10K---Install the battery pack and battery protection plate, then replace the front panel.



**Figure 3-14. Installing the Cabinet**

10. For 6K---Replace the battery tray, and connect the internal battery connector, then replace the protection plate and the front panel.
11. If installing additional UPSs, repeat from Step 1 to Step 8 for each cabinet.

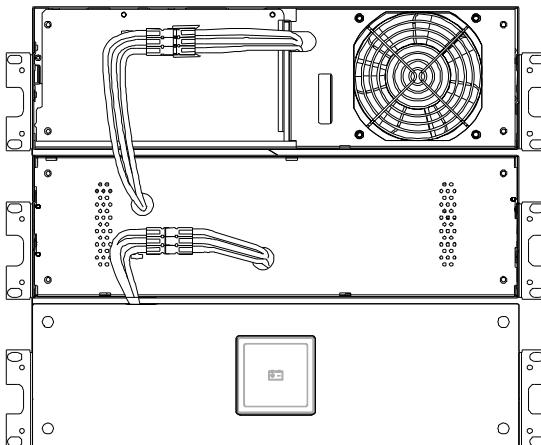
### **3.5.2 Installing the EBMs**

**Note:** A little of arcing may occur when connecting an EBM to the UPS. That is normal and not harmed. Plug the EBM cable into the UPS battery connector quickly and firmly.

To install EBM's:

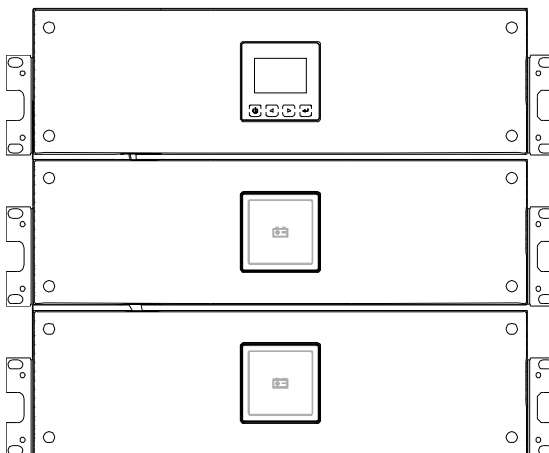
6K Model:

1. Plug the EBM cable into the UPS battery connector



**Figure 3-15. Plug the EBM cable into the UPS battery connector**

2. Replace UPS's front panel and EBM's front panel.



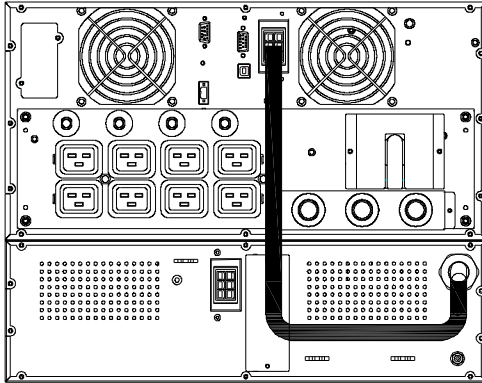
**Figure 3-16. Replace UPS's front panel and EBM's front panel.**



**CAUTION:**

Please connect the EBM to protective ground with 8 AWG wire for EBM model firstly.

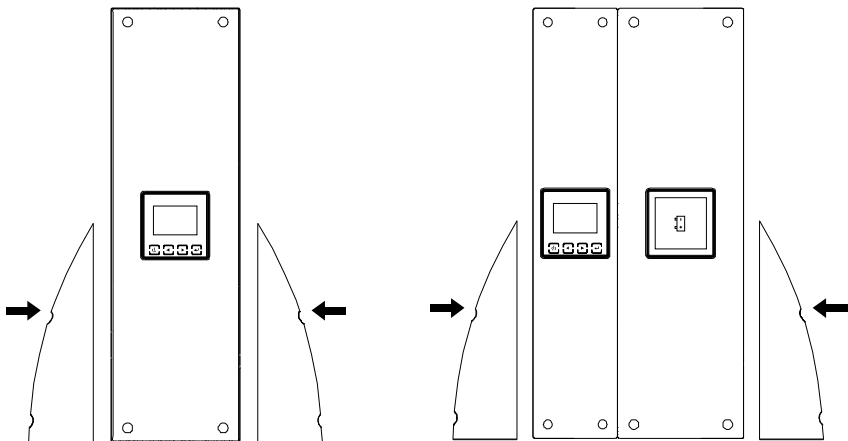
10K Model:



**Figure 3-17. Plug the EBM cable into the UPS battery connector**

### 3.6 Tower Setup

Tower setup as below:

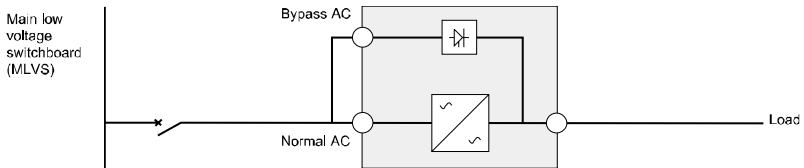


**Figure 3-18. Tower setup**

### 3.7 Installation of UPS with AC inputs

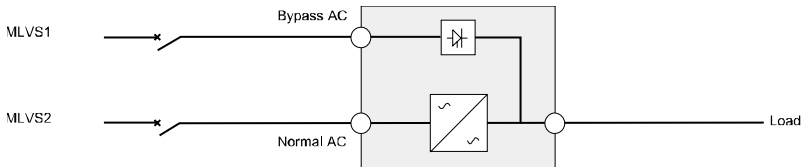
**CAUTION:** Online 6K/10K series support that the UPS can have separate AC inputs. So before connecting wires of separate AC inputs, you should confirm that their earthing systems are identical. Otherwise, a transformer is necessary.

#### UPS with common Normal and Bypass AC inputs



#### UPS with separate Normal and Bypass AC inputs

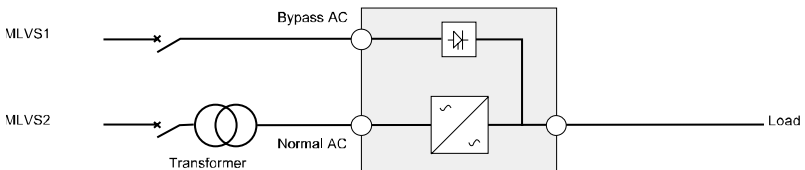
➤ Earthing systems are identical:



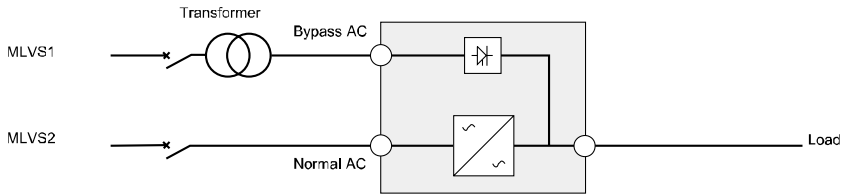
➤ Earthing systems are separate:

Three different installations can be chosen:

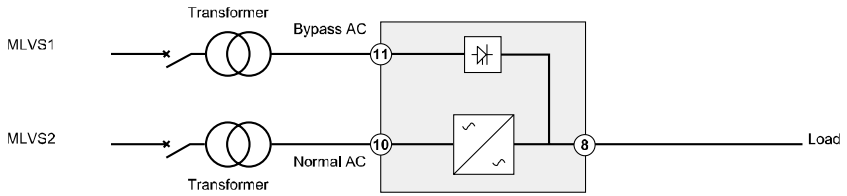
1) Transformer in the Normal AC input.



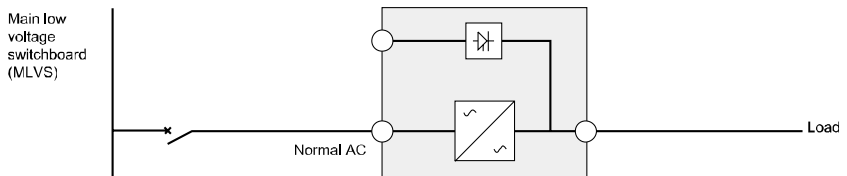
## 2) Transformer in the Bypass AC input.



## 3) Both of them have transformer



## Frequency converter (without Bypass AC input)



# 4. Power cables connection & Startup

This section explains:

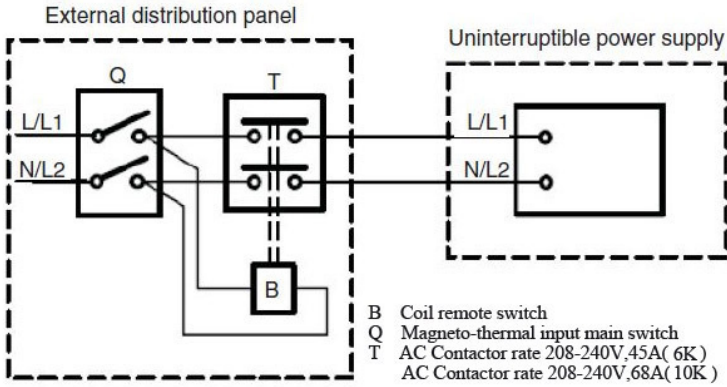
- Access to terminal block
- Common input sources connection
- Separate input sources connection
- Frequency converter connection
- UPS initial startup

Use cable cross section and protective device specification

<b>Model</b>	<b>PowerMust 6054 LCD RM</b>	<b>PowerMust 10900 LCD RM</b>
<b>Protective earthing conductor Min cross section</b>	4mm <sup>2</sup> (10AWG)	6mm <sup>2</sup> (8AWG)
<b>Input L, N, G Min conductor cross section</b>	4mm <sup>2</sup> (10AWG)	6mm <sup>2</sup> (8AWG)
<b>Input fuse</b>	60A	80A
<b>Output L,N, Min conductor cross section</b>	4mm <sup>2</sup> (10AWG)	6mm <sup>2</sup> (8AWG)
<b>External Battery Cabinet Positive Pole(+), Negative pole(-), Neutral Pole Min conductor cross section</b>	4mm <sup>2</sup> (10AWG)	2.5mm <sup>2</sup> *2 (12AWG*2)
<b>External Battery Cabinet Fuse in Positive Pole(+), Negative pole(-), Neutral Pole</b>	60A	80A

The UPS does not have an automatic protection device against current backfeed. It is suggested that install an external isolating device ,which is shown in the following illustration. Check for hazardous voltage between all terminals before operating on this circuit.





### 4.1 Access to terminal block

Access to terminal block: remove the 2 screws of the terminal block cover

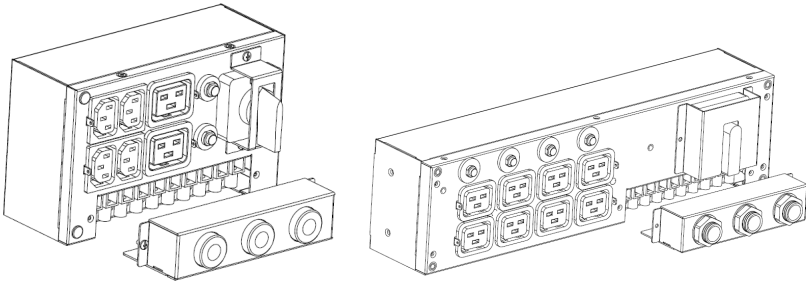


Figure 4-1a. PDU of 6K/10K

Need to reverse the cord bushing when wires connecting as below.

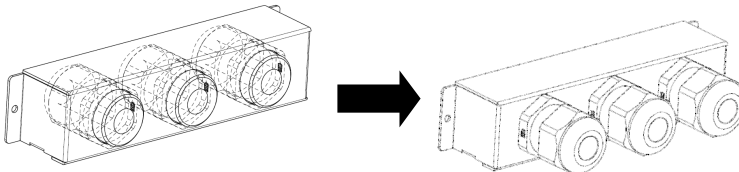


Figure 4-1b. PDU of 6K/10K

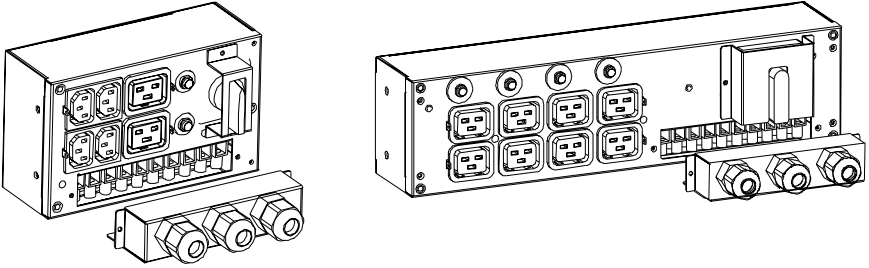


Figure 4-1c. PDU of 6K/10K

## 4.2 Common input sources connection



**CAUTION:**

This type of connection must be carried out by qualified electrical personnel



**CAUTION:**

Always connect the earthing wire first

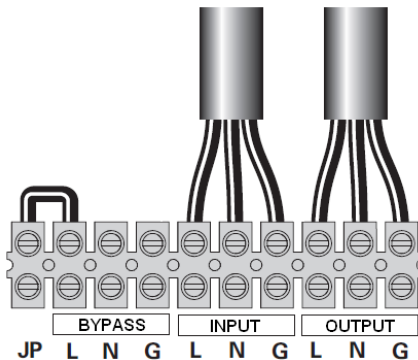


Figure 4-2. Common input sources connection

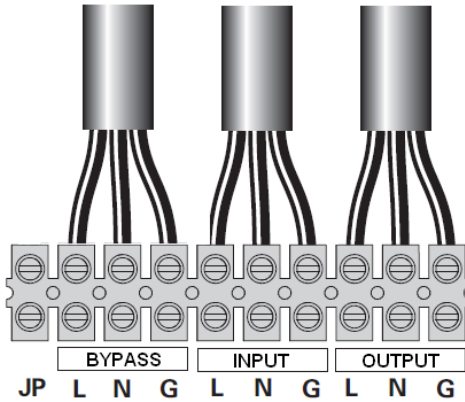
### 4.3 Separate input sources connection

 **CAUTION:**

This type of connection must be carried out by qualified electrical personnel.

 **CAUTION:**

Always connect the earthing wire first.



**Figure 4-3. Separate input sources connection**

## 4.4 Frequency converter connection

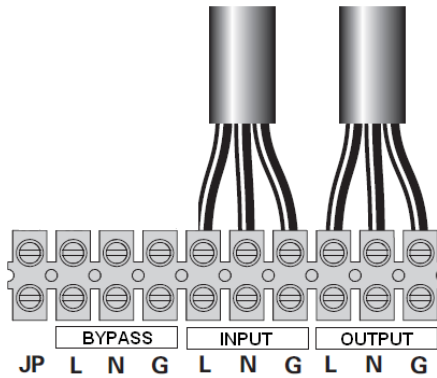


Figure 4-4. Frequency converter connection


## 4.5 UPS Initial Startup


To start up the UPS:

Verify that the total equipment ratings do not exceed the UPS capacity to prevent an overload alarm.

1. Verify that the internal batteries are connected.
2. If optional EBMs are installed, verify that the EBMs are connected to the UPS.
3. Set the upstream circuit breaker (not included) to the “I” position (ON).

The UPS display panel illuminates and shows a status of “Welcome”

4. Verify that the UPS transfers to Bypass mode.
5. Press the  button on the UPS front panel for at least three seconds.

The UPS display “  ” with flashing.

6. Check the UPS display for active alarms or notices. Resolve any active alarms before continuing. See “Troubleshooting”

7. Verify that the UPS is operating normally and any load is powered.
8. If optional EBMs are installed, see “Configuring the UPS for EBMs” to set the number of installed EBMs.
9. To change any other factory-set defaults, see “Operation”  
Online series recommends setting the date and time.  
At initial startup, the UPS sets system frequency according to input line frequency (input frequency auto-sensing is enabled by default). After initial startup, auto-sensing is disabled until manually re-enabled by output frequency setting.  
At initial startup, input voltage auto-sensing is disabled by default. When manually enabled by output voltage setting, at the next AC startup the UPS sets output voltage according to input line voltage. After the subsequent startup, auto-sensing is disabled until manually re-enabled by output voltage setting.
10. If you installed an optional REPO, test the REPO function:  
Activate the external REPO switch. Verify that status change on the UPS display.  
Deactivate the external REPO switch and restart the UPS.

## **4.6 Parallel Installation and Operation**

### **4.6.1 Brief introduction of the redundancy**

The parallel structure is 1+1. As long as the UPS is equipped with parallel cables, up to 2 UPSs can be connected in parallel to configure a sharing and redundant output power.

### **4.6.2 Installation and operation**

#### **How to install a new parallel UPS system:**

- 1) Before installing a new parallel UPS system, user need to prepare the input and output wires, the input and output breakers, and the parallel cable.

- 2) Users need to use a specialty 15-pin communication cable for this system, which should have 15 cores, corresponding stitches and shield, as the UPS parallel cable. The length of the parallel cable is appropriate to be less than 3 m.
- 3) Strictly follow the chapter of 4, the wiring requirement of single UPS to perform the wiring of each UPS.
- 4) Independent battery packs for each UPS.
- 5) Please connect the input and output wires, fix all the wiring according to the Figure 4-5 and make sure all these breakers are open.

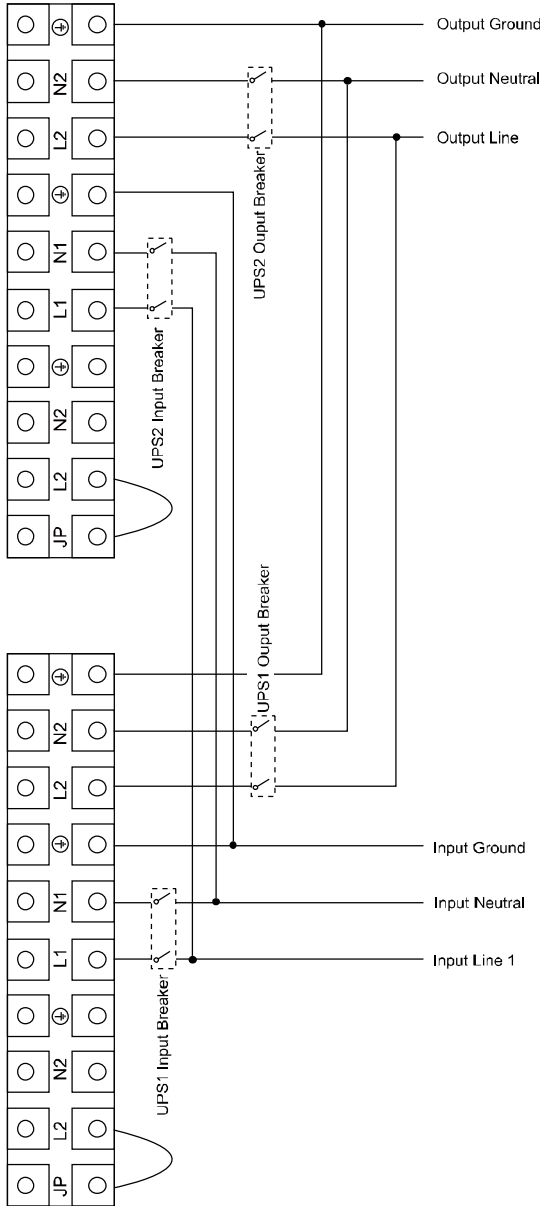


Figure 4-5.a: Parallel system wiring diagram of 6K/10K

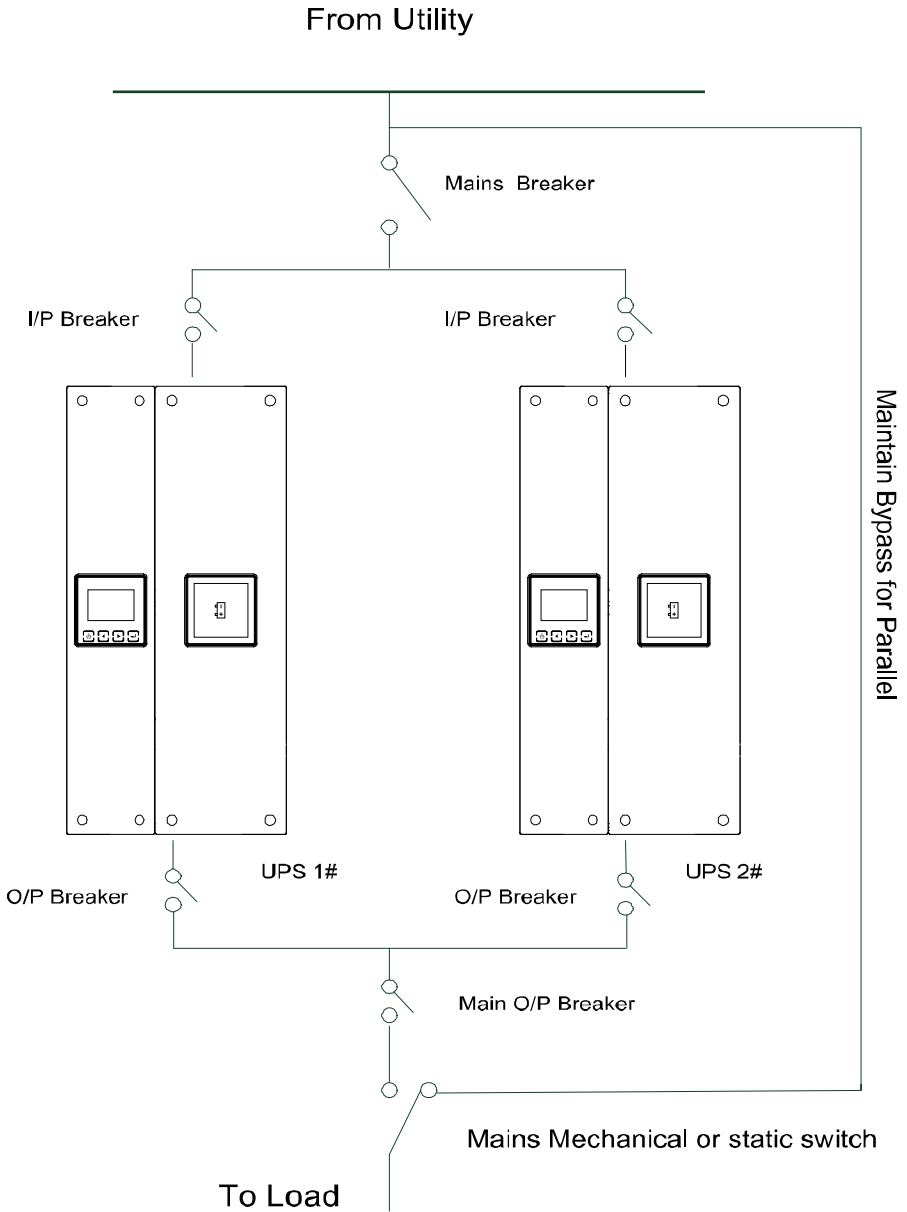



Figure 4-5.b: Parallel System Installation Diagram





- 6) Turn on the input breakers for the two parallel UPS.
- 7) Pressing  button continuously for more than 1 second for one UPS of the system, then the system will start to turn on and enter line mode.
- 8) Regulate the output voltage of the each UPS separately, and check if the output voltage difference between the two ups is less than 0.5V. If the difference is more than 0.5V, the UPS need to be regulated.
- 9) If the difference output voltage is less than 0.5V, switch on the output breakers for the two UPS separately and switch on the main O/P breakers, then the system will work normally in parallel.

■ **The output wiring requirement as follows:**



- When the distance between the UPS in parallel and the breaker panel is less than 10 meters, the length difference between input and output cable of the UPSs is required to be less than 20%.
- When the distance between the UPS in parallel and the breaker panel is more than 20 meters, the length difference between input and output cable of the UPSs is required to be less than 5%.

**How to join a new UPS to a parallel system:**

- 1) Firstly a main maintenance mechanical switch or static switch should be installed for the parallel system.
- 2) Regulate the output voltage of the new UPS: check if the output voltage difference between the new UPS and the parallel system is less than 0.5V.
- 3) Ensure the bypass of the parallel system is normal and the bypass setting is “enable”, then press the  button to turn off the UPS, then UPS will work in bypass mode.

- 4) Set the main maintenance switch or static switch from “UPS” to “BPS”, then switch off the main output breaker and the input breaker and mains breaker, then the UPS will shut down.
- 5) Connect the cable and wire of the added UPS according to the Figure.4-5.a and Figure.4-5.b
- 6) Switch on the input breakers and mains breaker, and make sure that every UPS work in bypass mode.
- 7) Switch on the O/P breakers and main O/P breaker · transfer the main maintenance switch or static switch from “BPS” to “UPS”.
- 8) Press the  button of one UPS, each UPS would start to turn on, after that, the two UPS should work parallel in Line mode.

**How to remove a single UPS from a parallel system:**

- 1) Firstly a main maintenance mechanical switch or static switch should be installed for the parallel system.
- 2) Ensure the bypass is normal and the bypass setting is “enable”, press the  button to turn off the UPS system, and the UPS system will work in bypass mode.
- 3) Transfer the main maintenance switch or static switch from “UPS” to “BPS”, then switch off the output breakers and the input breakers and mains breaker for the two UPS, and the UPS would shut down.
- 4) Switch off the main O/P breaker and O/P breaker for the UPS system.
- 5) Remove the wanted UPS and cables and wires.
- 6) Switch on the mains breaker and input breaker of the reserved UPS, make sure the UPS work in bypass mode.
- 7) Switch on the O/P breaker and main O/P breaker.
- 8) Transfer the main maintenance switch or static switch from “BPS” to “UPS”, and press the  button to turn on the UPS, and the UPS would start to turn on, then the UPS should work in Line mode.

# 5. Operation

## 5.1 Display Panel

The UPS has a four-button graphical LCD with dual color backlight. Standard back-light is used to light up the display with white text and a blue background. When the UPS has a critical alarm, the backlight changes the text to dark amber and the background to red. See Figure below

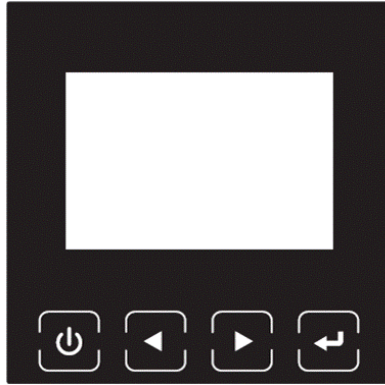


Figure 5-1. 6-10K Rack On-line UPS Control Panel

Table 5-1 Control Button Functions

The Button	Function	Illustration
	Power on	When the unit is no power and has connected with battery, press this button for >100ms&<1s to power on
	Turn on	When the unit is powered on and in Bypass mode, press this button for >1s to turn on
	Turn off	When the unit has been turned on, press this button for >3s to turn off




	Enter main menu	When displaying default UPS status summary screen, press this button for >1s to enter the main menu tree
	Exit main menu	Press this button for >1s to exit the present menu to default system status display menu without executing a command or changing a setting
	Scroll up	Press this button for >100ms&<1s to scroll up the menu option
	Scroll down	Press this button for >100ms&<1s to scroll down the menu option
	Enter next menu tree	Press this button for >100ms&<1s to select the present menu option, or enter next menu, but do not change any setting
	Select one menu option	Press this button for >100ms&<1s to select the present menu option, or enter next menu, but do not change any setting
	Confirm the present setting	Press this button for >1s to confirm the edited options and change the setting

Table 5-2 Buzzer definition

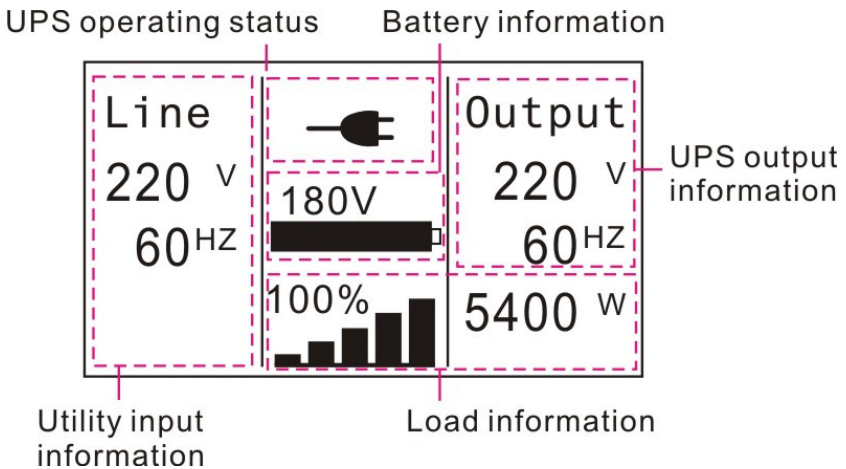
UPS condition	Buzzer status
Fault active	Continuous
Warning active	Beep every second
Battery output	Beep every 4 seconds, if battery low, buzzer Beep every second
Bypass output	Beep every 2 minutes

The UPS provides useful information about UPS itself, load status, events, measurements, identification, and settings through the front panel display.

After powering on, the LCD will display Welcome logo for several seconds and then enter to the default page which shows the UPS status summary. The display automatically returns to the default UPS status summary screen when no button has been pressed within 15 minutes.

On the UPS status summary screen it provides the following information:

- Status summary, including mode and load
- Alarm status, if any are present
  - Notes:** alarm including fault and warning information
- Battery and charger status, including battery voltage, charge level and charger status
- Running information and running time



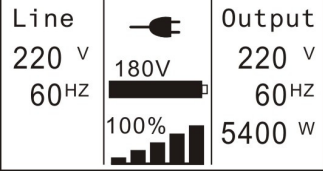
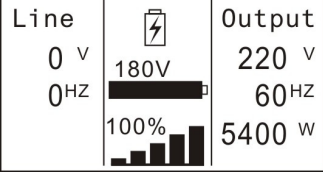
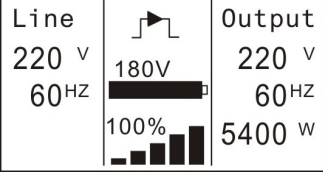
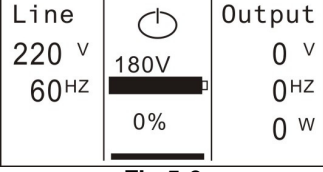
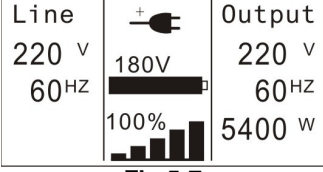
**Figure 5-2 The default LCD display**

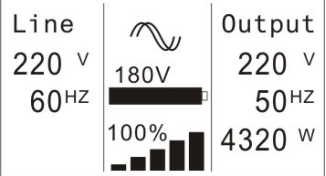
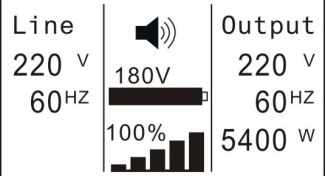
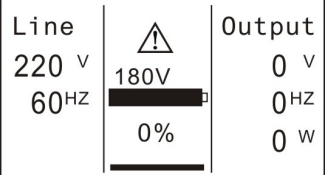
There are more operation details for LCD is illustrated in the chapter of 5.4

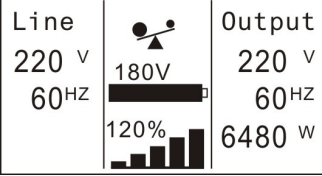
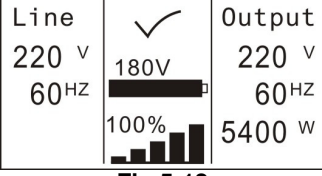
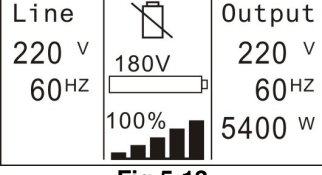
## 5.2 Operating mode

The different graphic symbol could be displayed corresponding to current operating mode or status.

Table 5-3 Status Summary Screens

Status Summary Screen		Description
 <p>Line 220 v 60HZ</p> <p>180V</p> <p>100%</p> <p>Output 220 v 60HZ 5400 w</p> <p><b>Fig 5-3</b></p>	<p><b>Normal mode:</b> The UPS is operating in Normal mode from utility power.</p>	
 <p>Line 0 v 0HZ</p> <p>180V</p> <p>100%</p> <p>Output 220 v 60HZ 5400 w</p> <p><b>Fig 5-4</b></p>	<p><b>Battery mode:</b> When the UPS is running in battery mode, the buzzer beeps once every 4 seconds.</p>	
 <p>Line 220 v 60HZ</p> <p>180V</p> <p>100%</p> <p>Output 220 v 60HZ 5400 w</p> <p><b>Fig 5-5</b></p>	<p><b>Bypass with output:</b> The UPS does not have the backup function when it is in bypass mode. The power used by the load is supplied from the utility power via internal filter. The UPS will beep once every 2 minutes in bypass mode.</p>	
 <p>Line 220 v 60HZ</p> <p>180V</p> <p>0%</p> <p>Output 0 v 0HZ 0 w</p> <p><b>Fig 5-6</b></p>	<p><b>Bypass without output:</b> The UPS in bypass mode without output</p>	
 <p>Line 220 v 60HZ</p> <p>180V</p> <p>100%</p> <p>Output 220 v 60HZ 5400 w</p> <p><b>Fig 5-7</b></p>	<p><b>High Efficiency Mode:</b> After the UPS is turned on, the power used by the load is supplied from the utility power via internal filter while the utility power is in normal range, so the high efficiency could be gained in the HE mode. Once the mains is loss or abnormal, the UPS would transfer to Line mode or Battery mode and the load is supplied continuously.</p> <p>1) The function could be enabled through the LCD setting or the</p>	

	<p>software (Winpower, etc.).</p> <p>2) It is attention that the transfer time of UPS output from HE mode to battery mode is about 10ms. But it is still too long for some sensitive load.</p>
 <p>Line 220 v 60HZ</p> <p>180V</p> <p>100%</p> <p>Output 220 v 50HZ 4320 w</p> <p><b>Fig 5-8</b></p>	<p><b>Converter mode</b></p> <p>In converter mode, the UPS would free run with fixed output frequency (50Hz or 60Hz). Once the mains is loss or abnormal, the UPS would transfer to battery mode and the load is supplied continuously.</p> <p>1) The function could be enabled through the LCD setting or the software (Winpower, etc.).</p> <p>2) The load should be derating to 80% in converter mode.</p>
 <p>Line 220 v 60HZ</p> <p>180V</p> <p>100%</p> <p>Output 220 v 60HZ 5400 w</p> <p><b>Fig 5-9</b></p>	<p><b>Warning:</b></p> <p>When the warning occurs, it illustrates that there are some abnormal problems during the operation of UPS. Normally the problems are not fatal and the UPS continues working, but they should be paid attention to, or the UPS may fail.</p>
 <p>Line 220 v 60HZ</p> <p>180V</p> <p>0%</p> <p>Output 0 v 0HZ 0 w</p> <p><b>Fig 5-10</b></p>	<p><b>Fault:</b></p> <p>When the fault occurs, it illustrates that some fatal problems happened, the UPS would directly cut off the output or transfer to bypass, and keep alarming. The backlight of LCD would also turn to red.</p>


 <p style="text-align: center;"><b>Fig 5-11</b></p>	<p><b>Overload:</b> When the UPS is overload, the alarm will beep twice every second. Some unnecessary loads should be get rid of one by one to decrease the loads connected to the UPS.</p>
 <p style="text-align: center;"><b>Fig 5-12</b></p>	<p><b>Battery Test</b> UPS is executing a battery test</p>
 <p style="text-align: center;"><b>Fig 5-13</b></p>	<p><b>Battery fail:</b> if the battery status detected is “bad battery detected” or “battery disconnected”, the symbol of battery failure would be shown and UPS would alarm.</p>

## 5.3 Turning on and Turning off UPS

**Attention:** The UPS could only be turning on while connecting with the utility for the first time.

**Attention:** Please switch off the connected loads at first before turning on the UPS, and switch on the loads one by one after the UPS is turned on. Switch off all of the connected loads before turning off the UPS.



### 5.3.1 Turning on UPS with utility

- 1) Check all the connection is correct.
- 2) Power on the UPS, the fan begins to rotate, LCD will show the “WELCOME” logo. After that, the LCD will show the default UPS status summary screen.
- 3) Pressing  button continuously for more than 1 second, the buzzer will beep 1s, UPS starts to turn on.




- 4) A few seconds later, the UPS turns into Line mode. If the utility power is abnormal, the UPS will transfer to Battery mode without output interruption of the UPS.


### **5.3.2 Turning on UPS without utility**

- 1) Check all the connection is correct.
- 2) Pressing  button continuously for more than 100ms, the UPS would be powered on. At this time the fan begins to rotate, LCD will show the “WELCOME” logo. Then LCD will show the default UPS status summary screen after UPS finishing self-test.
- 3) Pressing  button continuously for more than 1 second, the buzzer will beep for 1s, UPS starts to turn on.
- 4) A few seconds later, the UPS turns into Battery mode. If the utility power comes back, the UPS will transfer to Line mode without output interruption of the UPS.

### **5.3.3 Turning off UPS with utility**

- 1) Pressing  button continuously for more than 3 seconds and the buzzer will beep 3s. After that, the UPS will turn into Bypass mode at once.
- 2) When completing the above action, UPS output voltage is still present. In order to cut off the UPS output, simply cut off the utility power supply. A few seconds later, LCD display shuts down and no output voltage is available from the UPS output terminal.

### **5.3.4 Turning off UPS without utility**

- 1) To power off the UPS by pressing  button continuously for more than 3 second, and the buzzer will beep for 3s. The UPS will cut off the output at once.
- 2) A few seconds later, LCD shuts down and no voltage is available from the UPS output.

## 5.4 LCD operation

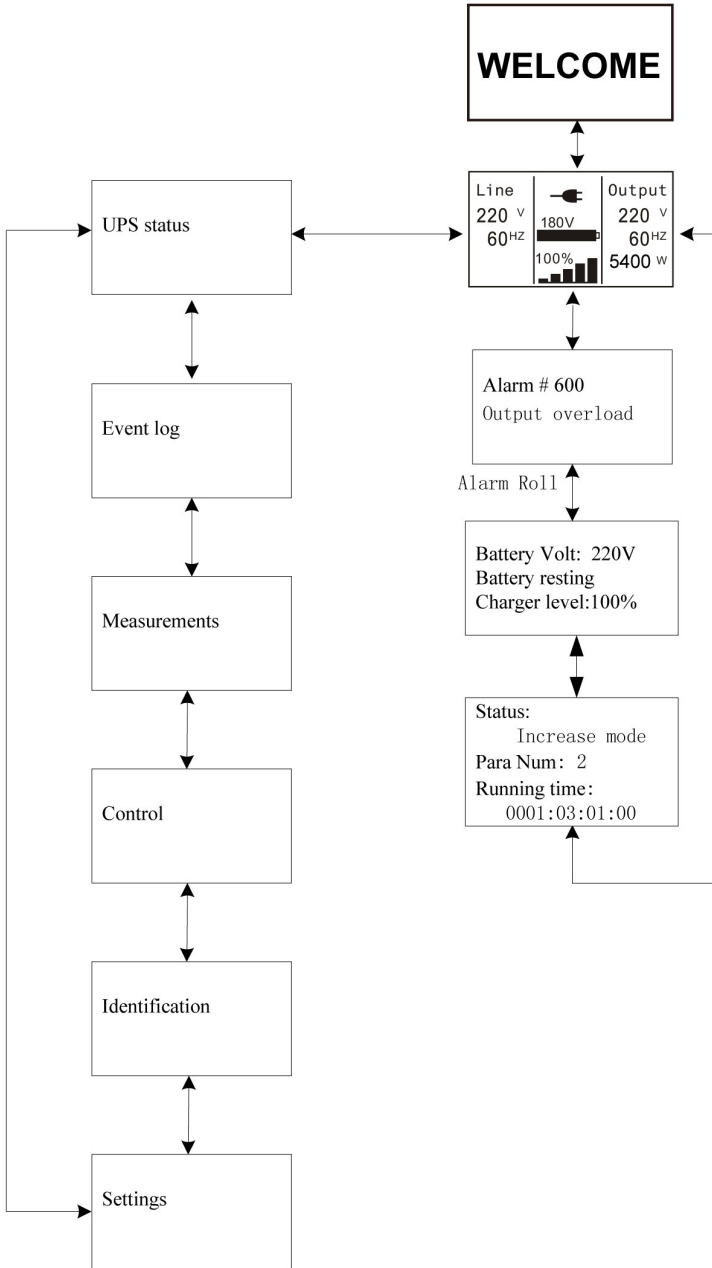
Except the default UPS status summary screen, the user could get more useful information about UPS current status, detailed various measurements, previous event records which ever occurred, UPS own identification, and could change the settings to fit the user own requirements, optimize the function of UPS.

### 5.4.1 The main menu

In the default UPS status summary screen, when pressing ◀ or ▶ <1s, the detailed information about alarm, the system status, battery would be shown.


In the default UPS status summary screen, when pressing ◀ >1s, the display would enter main menu tree.

The main menu tree includes six branches: UPS status menu, event log menu, measurement menu, control menu, identification menu and setting menu.




**Figure. 5-14 Main menu tree**

### 5.4.2 The UPS status menu


By pressing  on the menu of “UPS status”, the display would enter the next UPS status menu tree.

The content of UPS status menu tree is same as the default UPS status summary menu.



By pressing  >1s, the display would return the last main menu tree.

The detail information about “UPS status”, please see Fig5-14


### 5.4.3 The event log menu

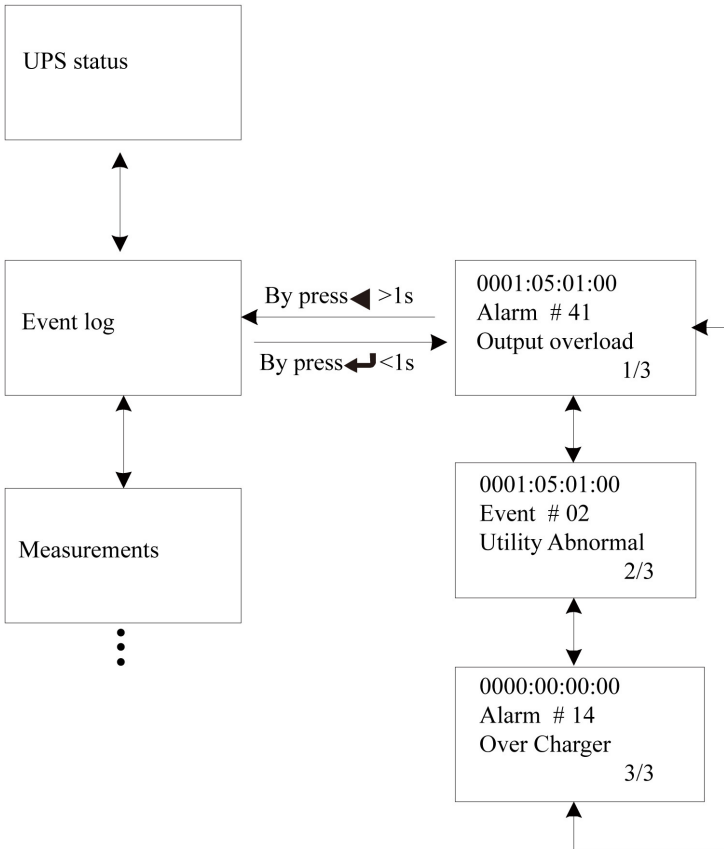
By pressing  on the menu of “Event log”, the display would enter the next event menu tree.

All the previous events, alarm and fault have been recorded here.

The information includes the illustration, the event code, and the precise time of UPS when the event happened. By press  or , <1s, all the events could be displayed one by one.

The max number of record is 50, when the number is larger than 50, the latest will replace the previous.

By pressing  >1s, the display would return the last main menu tree.



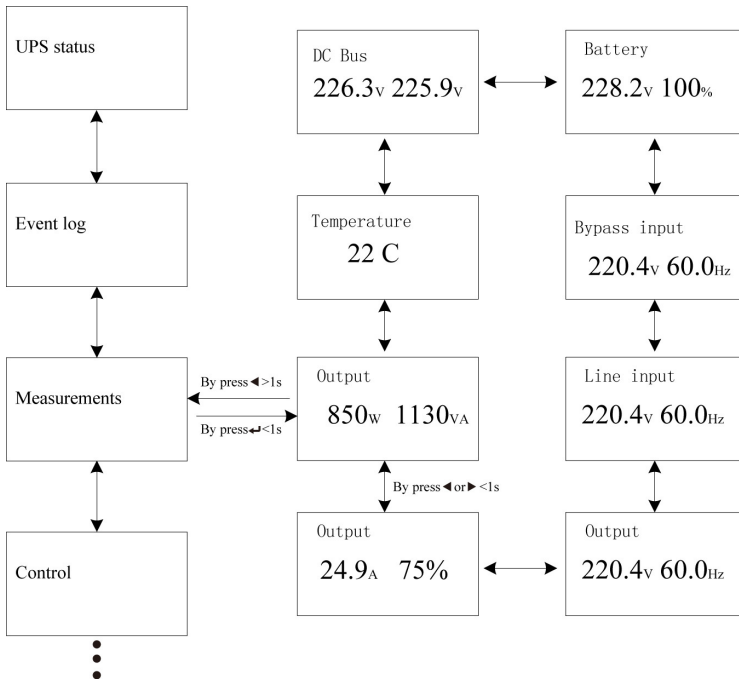
**Figure. 5-15 Event menu tree**

#### 5.4.4 The measurement menu

By pressing ⏏ on the menu of "Measurement", the display would enter the next measurement menu tree.


A lot of detailed useful information could be checked here, Ex. the output voltage and frequency, the output current, the load capacity, the input voltage and frequency, etc.

By pressing ◀ >1s, the display would return the last main menu tree.



**Figure. 5-16 Measurement menu tree**

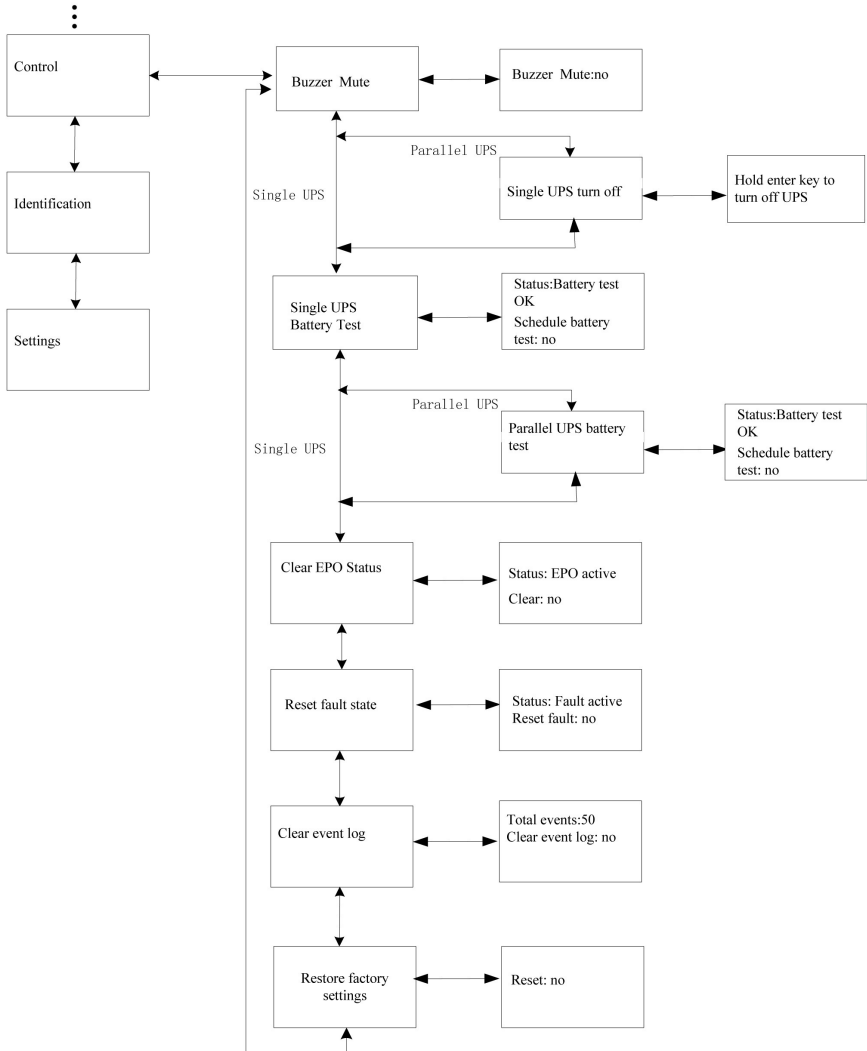
### 5.4.5 The control menu

By pressing  on the menu of "Control", the display would enter the next control menu tree.

- 1) Start Battery Test: this is one command that control the UPS to do the battery test.
- 2) Clear EPO status: once EPO status is enabled, the UPS output would be cut off. To recover to normal status, first EPO connector should be closed, and enter this menu to clear EPO status, then UPS would stop alarm and recover to Bypass model. And UPS needs be turned on by manual operation.
- 3) Reset Fault status: when fault occurs, UPS would keep in Fault mode and alarm. To recover to normal status, enter this menu


to reset error status, then UPS would stop alarm and recover to Bypass mode. And the reason of fault should be checked and deleted before UPS is turned on again by manual operation.

- 4) Restore factory settings: all the settings would be recover to default factory settings. It could only be done in Bypass mode.




**Figure. 5-17 Control menu tree**

### 5.4.6 The identification menu

By press  on the menu of “Identification”, the display would enter the next identification menu tree.

The identification information includes UPS serial number, firmware serial number, model type, would be shown here.

By press  >1s, the display would return the last main menu tree.

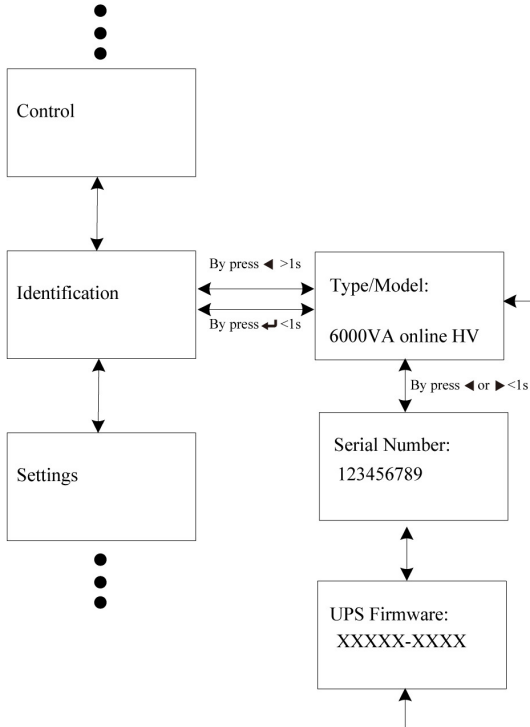


Figure. 5-18 Identification menu tree

### 5.4.7 The setting menu

Please contact your local distributor for further information before using the settings. Some settings would be changed the specification, and some settings would enable or disable some functions. The unsuitable option setting by user may result in potential failures or protecting function loss, even directly damage the load, battery or UPS.



Most of settings could only be done while UPS is in Bypass mode.

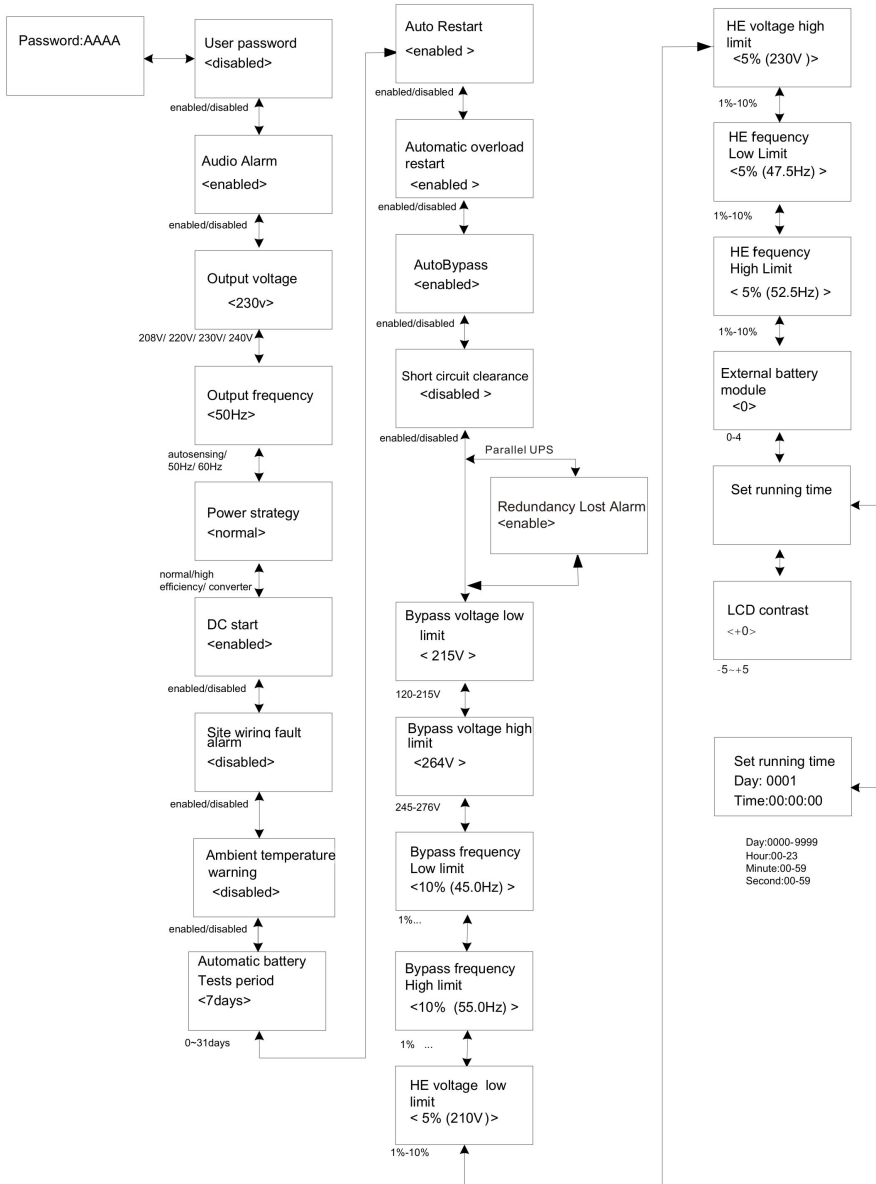


Figure. 5-19 Setting menu tree

## Example: set rated output voltage value

Setting menu tree

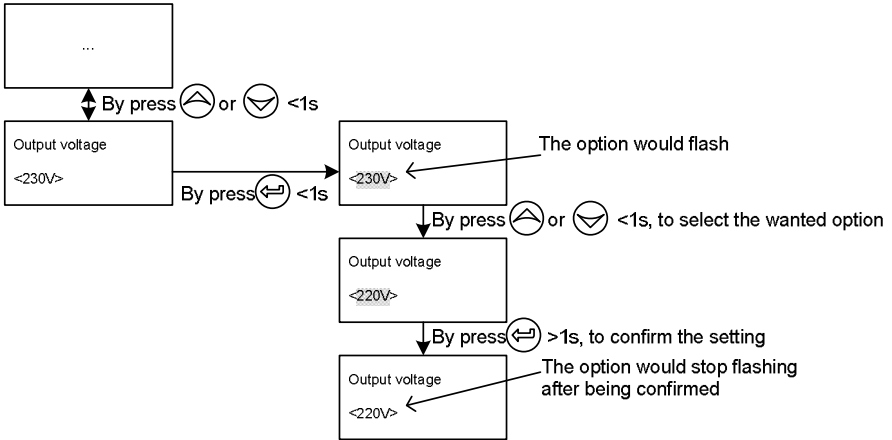


Figure. 5-20 Set rated output voltage value

## 6. UPS Maintenance

This chapter explains how to:

- Care for the UPS and batteries
- Transport the UPS
- Store the UPS and batteries
- Test the batteries
- Recycle the used Battery or UPS

### 6.1 UPS and Battery Care

For the best preventive maintenance, keep the area around the UPS clean and dust-free. If the atmosphere is very dusty, clean the outside of the system with a vacuum cleaner. For full battery life, keep the UPS at an ambient temperature of 25°C (77°F)

Note: The batteries in the UPS are rated for a 3-5 year service life. The length of service life depends on the frequency of usage and ambient temperature. Batteries used beyond expected service life will often have severely reduced runtimes. Replace batteries at least every 5 years to keep units running at peak efficiency.

### 6.2 Transporting the UPS

**NOTE:** The internal UPS batteries **MUST** be disconnected before transport.

**CAUTION:** The following procedure should be performed or supervised by personnel knowledgeable about batteries and the required precaution. Keep unauthorized personnel away from batteries.

If the UPS requires any type of transportation, the batteries must be disconnected (but not removed) before the unit is transported:

1. Verify that the UPS is off and disconnected from utility power.
2. Place the UPS on a flat, stable surface with the front of the cabinet facing you.
3. Remove the UPS front cover

4. Disconnect the internal battery connectors
5. Replace the UPS front cover

### 6.3 Storing the UPS and Batteries

If you store the UPS for a long period, recharge the battery every 6 months by connecting the UPS to utility power. The batteries charge to 90% capacity in approximately 4 hours. However, it is recommended that the batteries charge for 48 hours after long-term storage.

Check the battery recharge date on the shipping carton label. If the date has passed and the batteries were never recharged, do not use the UPS. Contact your service representative.

#### When to Replace Batteries






When the status summary screen displays the UPS fault icon with the “Service Battery” alarm and the audible alarm sounds continuously, the batteries may need replacement. Contact your service representative to order new batteries.

### 6.4 Testing Batteries

For a battery test, please check:

- The batteries must be fully charged.
- The UPS must be in Normal mode with no active alarms.
- The load must be higher than 10%.

To test batteries:

- 1 Connect the UPS to utility power for at least 48 hours to charge the batteries.
- 2 Press the  button for one second to go to the main menu selection and scroll down to the Control menu using the  button.
- 3 Press the  button to enter the Control menu.
- 4 Use the  button to scroll to the Battery Test option.
- 5 Press the  button to start the battery test.

During the battery test, the UPS transfers to Battery mode and discharges the batteries for 25% of the original expected runtime. The status screen displays "Battery test running" and the percentage of the test completed. The results display on the UPS status screen as completing.

## **6.5 Recycling the Used Battery or UPS**

Contact your local recycling or hazardous waste center for information on proper disposal of the used battery or UPS.

# 7. Specifications

This chapter provides the following specifications:

- Model list
- General Specification
- Electrical Performance
- Environmental and Safety

## 7.1 Electrical specification

Model	PowerMust 6054 LCD RM	PowerMust 10900 LCD RM
<b>Output</b>		
Power Capacity	6KVA/5.4KW	10KVA/9KW
Voltage Range	208VAC/220VAC/ 230VAC/ 240VAC	208VAC/220VAC/ 230VAC/ 240VAC
Frequency	50/60Hz	50/60Hz
Voltage Distortion	<5%@Nonlinear load <2%@Linear load	<5%@Nonlinear load <2%@Linear load
Over Load	Line Mode: 2mins 102% ~ 130% 30s 130% ~ 150% 100ms >150% Battery Mode: 10s 102% ~ 130% 100ms >130%	
<b>Efficiency</b>		
Line mode	>92%	>93%
ECO mode	>96%	>97%
Battery mode	>89%	>90%
<b>Input</b>		
Input wire	1 Ph (L1,L2/N)+ PE	
Input Type	Support dual input	
Phase	single	
Voltage Range	176-276Vac	
Frequency Range	(45~55)/(54~66)Hz	

Current	26.4A@230Vac	44.0A@230Vac
Power Factor	$\geq 0,99$ @100% Nominal Load $\geq 0,98$ @50% Nominal Load $\geq 0,95$ @25% Nominal Load	
THDI	< 5 %@Full load and battery full charged	
<b>Battery &amp; Charger</b>		
Battery	180VDC/5Ah	240VDC/9Ah
Current	39A	48A
Charger current	>1A	>1.7A

## 7.2 Typical Backup Time (Typical values at 25 °C in minutes)

Model No.	100 % Load	50 % Load
PowerMust 6054 LCD RM	3	8.4
PowerMust 10900 LCD RM	3.9	12.5

## 7.3 Dimension and Weight

Dimension (W*D*H) mm	438*698*129	438*704*215.5
Net Weight (KG)	46	82.5
Gross Weight (KG)	50	87.5

## 7.4 Operating Environment

Item	Specification/Function	Standards/Comments
Cooling	Force Air Cooling	
Operating Temperature Range	0 °C ~ 40 °C	Nominal power & continuous operating mode
Storage Temperature	-15 °C~60 °C	UPS
	0~35 °C	Battery
Relative Humidity	0-95%	No condensing
Altitude	<1000m for Nominal power	Over 1000 m the power derating is 1 % every 100 m
Acoustic Noise	<55dB	<55dB

# 8. Troubleshooting

The online series UPS is designed for durable, automatic operation and issues alarms to alert you whenever potential operating problems occur. Usually the alarms shown by the control panel do not mean that the output power is affected. Instead, they are preventive alarms intended to alert the user. Active alarms are accompanied by an audible buzzer.

The control panel provides troubleshooting information from two main menus:

- UPS status menu: Access to all active alarms
- Event Log menu: Access to the most recent 50 events, which may include active and closed alarms

## 8.1 Typical Alarms and Conditions

Alarm or Condition	Possible cause	Action
ON Maintenance Bypass Alarm Code: 72	UPS was manually commanded to switch to bypass and will remain in bypass until commanded out of bypass	Check the maintain bypass switch status
In Battery Mode Alarm Code: 62	A utility failure has occurred and the UPS is in Battery mode.	The UPS is powering the equipment with battery power. Prepare your equipment for shutdown.
In ECO Mode Alarm Code: 63	The UPS is on bypass while operating on the High Efficiency setting.	The equipment transferred to bypass utility power as a normal function of High Efficiency operation. Battery mode is available and your equipment is protected.
EPO Active Alarm Code: 71	The external contacts in the rear of the UPS are configured for REPO operation and they have been activated.	Check the EPO connector status



Site Wiring Fault Alarm Code: 04	Site Fault detection is supported on all models anytime there is a Grounding Neutral connection. Alarm triggers when the difference between ground and neutral voltage is > 15v.	Site Fault detection should be enabled by default. It can still be enabled / disabled from the LCD settings menu. Reconnect all input wires
Utility Abnormal Alarm Code: 02	Utility is out of the tolerance of input	Check input mains condition
Back feed Alarm Code:93	UPS has a unexpected bypass current on battery mode	Transfer to maintenance bypass and call service.
Battery Disconnect Alarm Code:11	Battery voltage is lower than the batteries disconnected level defined for this UPS. This may be due to a blown fuse, intermittent battery connection or battery cable being disconnected.	Verify that all batteries are properly connected. If the condition persists, contact your service representative.
Battery low Alarm Code:12	The UPS is in Battery mode and the battery is running low	This warning is approximate, and the actual time to shutdown may vary significantly. Depending on the UPS load and number of Extended Battery Modules(EBMs), the "Battery Low" warning may occur before the batteries reach 25% capacity
Service Battery Alarm Code:13	A faulted battery string has been detected and as a result the battery charger has been disabled until it is replaced	Contact your service representative

Output Overload Alarm Code:41	Output is overload.	Remove some of the equipment from the UPS. The UPS continues to operate, but may switch to Bypass mode or shutdown if the load increases. The alarm resets when the condition becomes inactive.
Inv Overload Fault Alarm Code:42	UPS has transferred to bypass or fault mode because of overload in inverter mode	The UPS transfers to Battery mode if supporting the load. Remove some of the equipment from the UPS
Byp Overload Fault Alarm Code:43	UPS has cut off the output and transferred to fault mode because of overload in bypass mode or HE mode.	Remove some of the equipment from the UPS
Output Short Circuit Alarm Code:31	Indicates that the UPS has detected abnormally low impedance placed on its output and considers it a short circuit	Remove all the loads. Turn off the UPS. Check if UPS output and loads is short circuit. Ensure short circuit is removed before turning on again.
Fan Failure Alarm Code:84	Indicates that the fan could not work normally.	Check fans of UPS
Heatsink Over Temperature Alarm Code:81	Indicates that the temperature of heatsink is too high, UPS will get over temperature fault soon.	If the UPS transferred to Bypass mode, If the condition persists, shut down the UPS. Clear vents and remove any heat sources. Allow the UPS to cool. Ensure the airflow around the UPS is not restricted. Restart the UPS.
Ambient Over Temperature Alarm Code:82	Indicates that the ambient temperature is higher than the operation temperature on specification	

BUS Over Voltage Alarm Code:21	Indicates that the UPS get BUS over voltage fault because of BUS.	The UPS transfers to Bypass mode if supporting the load
BUS Under Voltage Alarm Code:22	Indicates that the UPS get BUS under voltage fault	The UPS transfers to Bypass mode if supporting the load
BUS Unbalance Alarm Code:23	Indicates that the positive BUS voltage and negative BUS voltage are too lopsided to fault	The UPS transfers to Bypass mode if supporting the load
BUS Short Alarm Code:24	Indicates that the BUS voltage decrease very fast	Contact your service representative
BUS Softstart Fail Alarm Code:25	Indicates that the BUS could not soft start successfully	Contact your service representative
Inv Over Voltage Alarm Code:32	Indicates that the UPS get invert over voltage fault	The UPS transfers to Bypass mode if supporting the load
Inv Under Volatge Alarm Code:33	Indicates that the UPS get inverter under voltage fault	The UPS transfers to Bypass mode if supporting the load
Inv Softstart Fail Alarm Code:34	Indicates that the inverter could not soft start successfully	Contact your service representative
Charger Fail Alarm Code:15	Indicates that the UPS has confirmed the charger has failed	The UPS turns off the charger until the next power recycle. Contact your service representative
Battery Over Voltage Alarm Code:16	Indicates that the battery voltage is too high	The UPS will turn off the charger until the battery voltage is normal
Fatal eeprom Fault Alarm Code:A3	Indicates that the UPS could not read eeprom successfully	Contact your service representative
Negative power Fault Alarm Code: E1	In parallel system , power of UPS is negative	Redundancy mode, the fault UPS turn to fault mode without output Increase mode, UPS1& UPS2 turn to fault mode

Parallel cable loss Alarm Code: E2	In parallel system , parallel cable disconnect	Disconnect parallel cable one turn to fault mode
Parallel system battery status Alarm Code: E6	UPS1 connect battery , UPS2 without battery	Check battery connect status
Line input different Alarm Code: E7	Parallel system , UPS1 line ok , UPS2 line loss	Check the line input
Bypass input different Alarm Code: E8	Parallel system , UPS1 bypass ok , UPS2 Bypass loss	Bypass different, not allow turn on UPS. Check bypass input
Power strategy different Alarm Code: E9	Parallel system , UPS OP mode ( normal , converter , HE ) different	Check UPS OP mode, Keep OP mode be the same
Rate power different Alarm Code: EA	Parallel system rate power different	Rate power different, not allow turn on UPS. Keep rate power be the same
HE in parallel Alarm Code: EB	Parallel system , OP mode set as HE	HE not allow in parallel system, change OP mode
Redundancy lost Alarm Code: ED	Parallel system , Redundancy lost alarm enable, system load is increase	“Redundancy lost” only notice client that system isn't redundancy。 Redundancy lost alarm disable can make this alarm disappear。

# 9. Communication

This chapter contains:

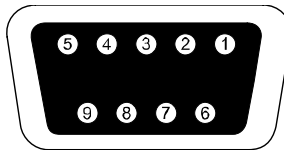
- Communication ports (RS-232 and USB)
- Network Management Card (Optional)
- UPS Management Software
- REPO

## 9.1 RS-232 and USB Communication Ports

To establish communication between the UPS and a computer, connect your computer to one of the UPS communication ports using an appropriate communication cable.

When the communication cable is installed, power management software can exchange data between you computer and the UPS. The software will obtain the detailed information of the UPS on the status of the power environment. If power emergency occurs, the software initiates the saving of all data and an orderly shutdown of the equipment.

The cable pins for the RS-232 communication port are identified in figure 9-1, and the pin functions are described in Table 3.

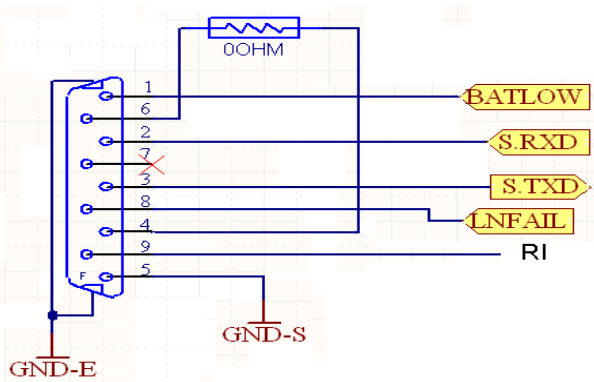


**Figure.9-1 RS-232 Communication Port (DB-9 Connector)**

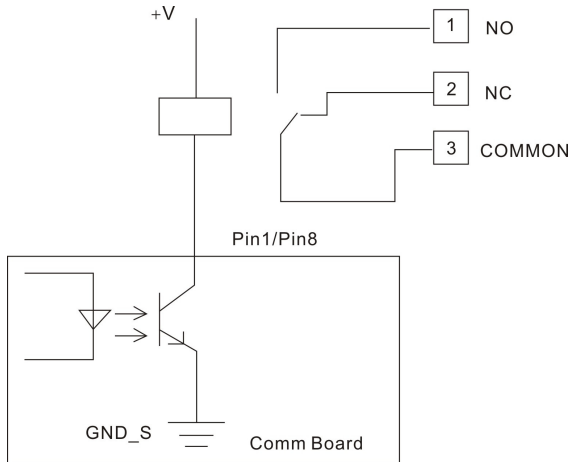
**Table 3 RS-232 Communication Port Pin Assignment**

Pin Number	Signal Name	Function	Direction from the UPS
1		Battery Low signal	Out
2	RxD	Transmit to external device	Out
3	TxD	Receive from external device	In
5	GND	Signal common	--

7		Not used	--
8		On Battery signal	Out
9		Vdc Power (+12V) This pin is connected via a jumper to pin 2 of SNMP connector	Out



**Figure.9-2 RS-232 Communication Port**



**Figure. 9-3 Pin1/Pin8 typical application**

**Notes:** The voltage of 'V' is maximum 30VDC, and current is maximum 45mA.

## 9.2 Network Management Card (Optional)

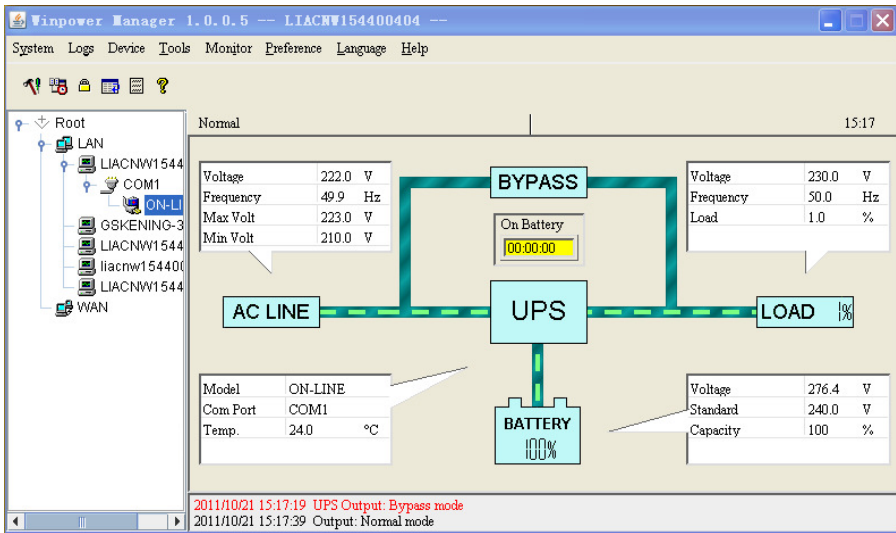
Network Management Card allow the UPS to communicate with different types of devices in variety of networking environments. The Online series has one available communication bay for the following connectivity cards:

- **Connect UPS- MS Web/SNMP Card** – has SNMP and HTTP capabilities as well as monitoring through a Web browser interface; connects to a twisted-pair Ethernet (10/100BaseT) network. In addition.
- This series UPS has AS400 card (an optional accessory) for AS400 communication protocol. Please contact your local distributor for details.

## 9.3 UPS Management Software

### Free Software Download – WinPower

WinPower is a new software for UPS monitoring, which provides user-friendly interface to monitor and control your UPS. This unique software provides safely auto shutdown for multi-computer systems while power failure. With this software, users can monitor and control any UPS on the same LAN no matter how far from the UPSs.



## Installation procedure:

1. Go to the website:

<http://www.ups-software-download.com/>

2. Choose the operation system you need and follow the instruction described on the website to download the software.
3. When downloading all required files from the internet, enter the serial No: **511C1-01220-0100-478DF2A** to install the software.

When you finish installation, restart your computer, the WinPower software will appear as a green plug icon located in the system tray, near the clock.

## 9.4 REPO Function

The Remote Emergence Power Off interface provides an emergence power off function. When the REPO function is enabled, once the EPO port is pulled out, the UPS would shut off the output and enter into EPO mode, and the UPS would not respond anything command unless the port is plugged back.



